

50Ω DC to 26.5 GHz

### The Big Deal

- Mechanical SP6T switch
- Excellent performance to 26.5 GHz
- High reliability, 2 million switch cycles
- 5W power rating (cold switching)

### Typical Applications

- 5G node / device testing
- Automated test equipment
- Fail-safe / redundancy switching



Case Style: PF2909



Software Package

**RoHS Compliant**

See our web site for RoHS Compliance methodologies and qualifications

### Product Overview

Mini-Circuits' RC-1SP6T-26 is an electro-mechanical SP6T switch operating over an extremely wide bandwidth, from DC to 26.5 GHz with high isolation and low insertion loss. The absorptive switch is of a failsafe and break-before-make-configuration, with a minimum lifetime of 2 million cycles per switch position, when used within the noted specifications.

The switch box is constructed in a compact, rugged metal case (5.5 x 6.0 x 2.75") with 7 SMA (f) RF connectors on the front panel. The switch is controlled via USB or Ethernet, allowing control directly from a PC, or remotely over a network. Full software support is provided, including our user-friendly GUI application for Windows and a full API with programming instructions for Windows and Linux environments (both 32-bit and 64-bit systems).

### Key Features

Feature	Advantages
Mechanical SP6T switch	Mechanical absorptive switches provide high reliability, repeatable high performance and internal terminations of input signals on the disconnected paths
Operation from DC to 26.5 GHz	Supports a wide range of RF test and signal routing applications, including 2G, 3G, 4G and 5G, with a single device
Break-before-make configuration	Prevents a momentary connection of the old and new signal paths, reducing the inconsistent transient effects that could otherwise be observed during switching
USB & Ethernet control	USB HID and Ethernet (HTTP / Telnet) interfaces provide easy compatibility with a wide range of software setups and programming environments
Full software support	User friendly Windows GUI (graphical user interface) allows manual control straight out of the box, while the comprehensive API (application programming interface) with examples and instructions allows easy automation in most programming environments

## Electrical Specifications at 25°C

Parameter	Conditions	Min.	Typ.	Max.	Units
Frequency Range		DC		26.5	GHz
Insertion Loss	DC - 8 GHz	—	0.10	0.30	dB
	8 - 18 GHz	—	0.25	0.50	
	18 - 26.5 GHz	—	0.40	0.70	
Isolation	DC - 6 GHz	70	90	—	dB
	6 - 18 GHz	60	90	—	
	18 - 26.5 GHz	55	80	—	
VSWR	DC - 8 GHz	—	1.20	—	:1
	8 - 18 GHz	—	1.35	—	
	18 - 26.5 GHz	—	1.50	—	
Switching Time	—	—	25	—	ms
RF Input Power (Cold Switching) <sup>1</sup>	DC - 8 GHz	—	—	20	W
	8 - 18 GHz	—	—	10	
	18 - 26.5 GHz	—	—	5	
Switch Lifetime	100mW hot switching <sup>2</sup>	2	—	—	million cycles
	1W hot switching	—	1	—	
Rated Voltage	24V <sub>DC</sub> input	23	24	25	V
	USB port	—	5	—	
Rated Current (24V DC Input)	in state 1-6	—	330	—	mA
	in state 0	—	90	120	
Rated Current (USB)		—	10	20	mA

<sup>1</sup> Maximum power for any connected through path as stated; maximum power into any internal termination is 1W per port, 3W total per switch

<sup>2</sup> Hot switching powers above this level will degrade the switch lifetime

## Absolute Maximum Ratings

Operating Temperature	0°C to 40°C
Storage Temperature	-15°C to 85°C
Supply Voltage	26V

## Switching Configuration:

- Normally open (all port disconnected)
- Absorptive (internal terminations on ports J1-J6)

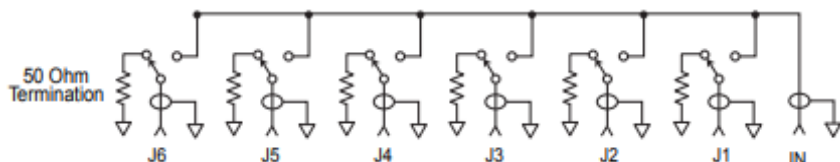

## Connections

Port Name	Connector Type
RF Switch A (Com, 1, 2, 3, 4, 5 & 6)	SMA female
USB	USB type-B
Ethernet / LAN	RJ45
24V <sub>DC</sub> Input	2.1mm center positive DC socket

## Typical Performance Data

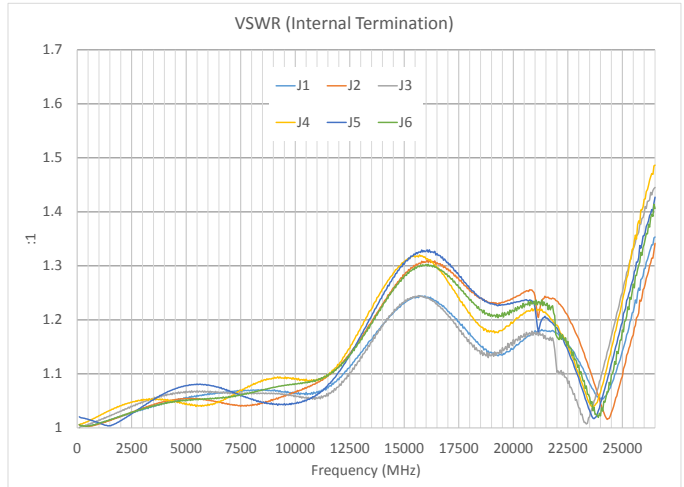
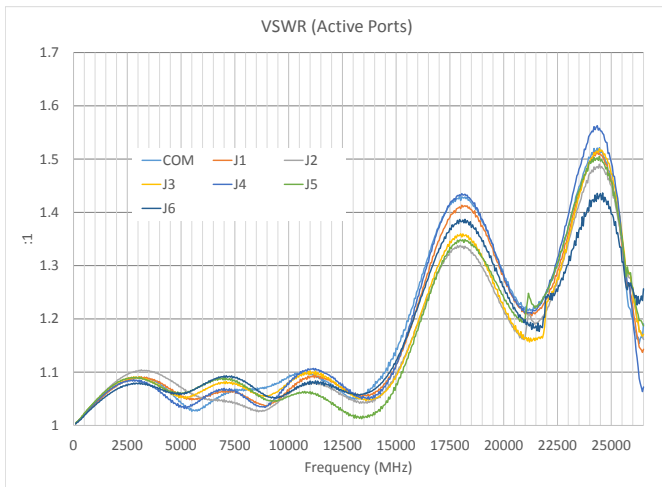
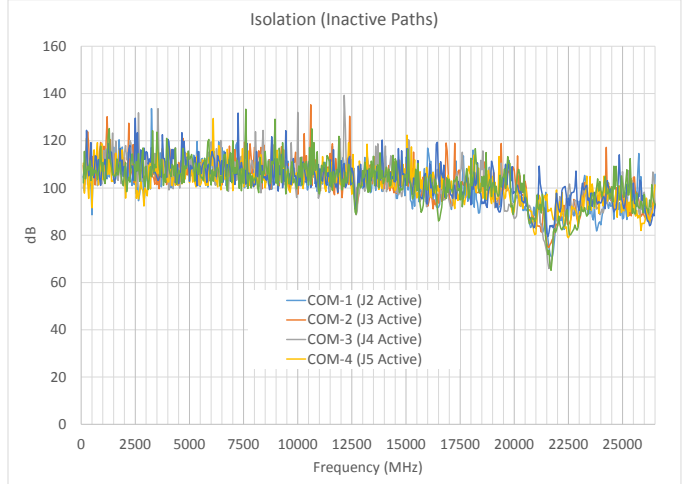
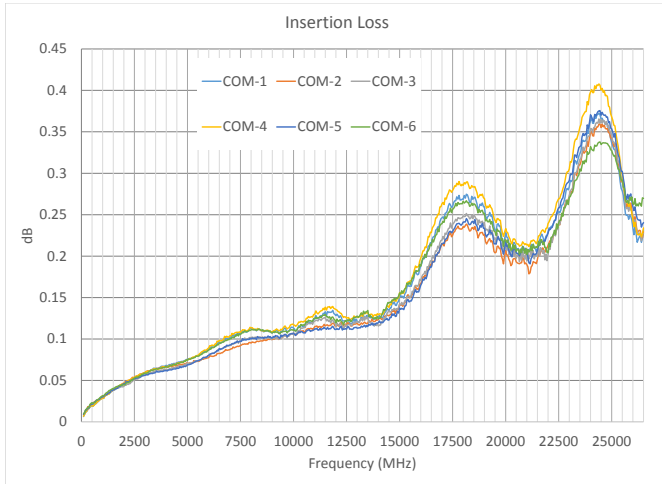

## Outline Drawing (PF2909)

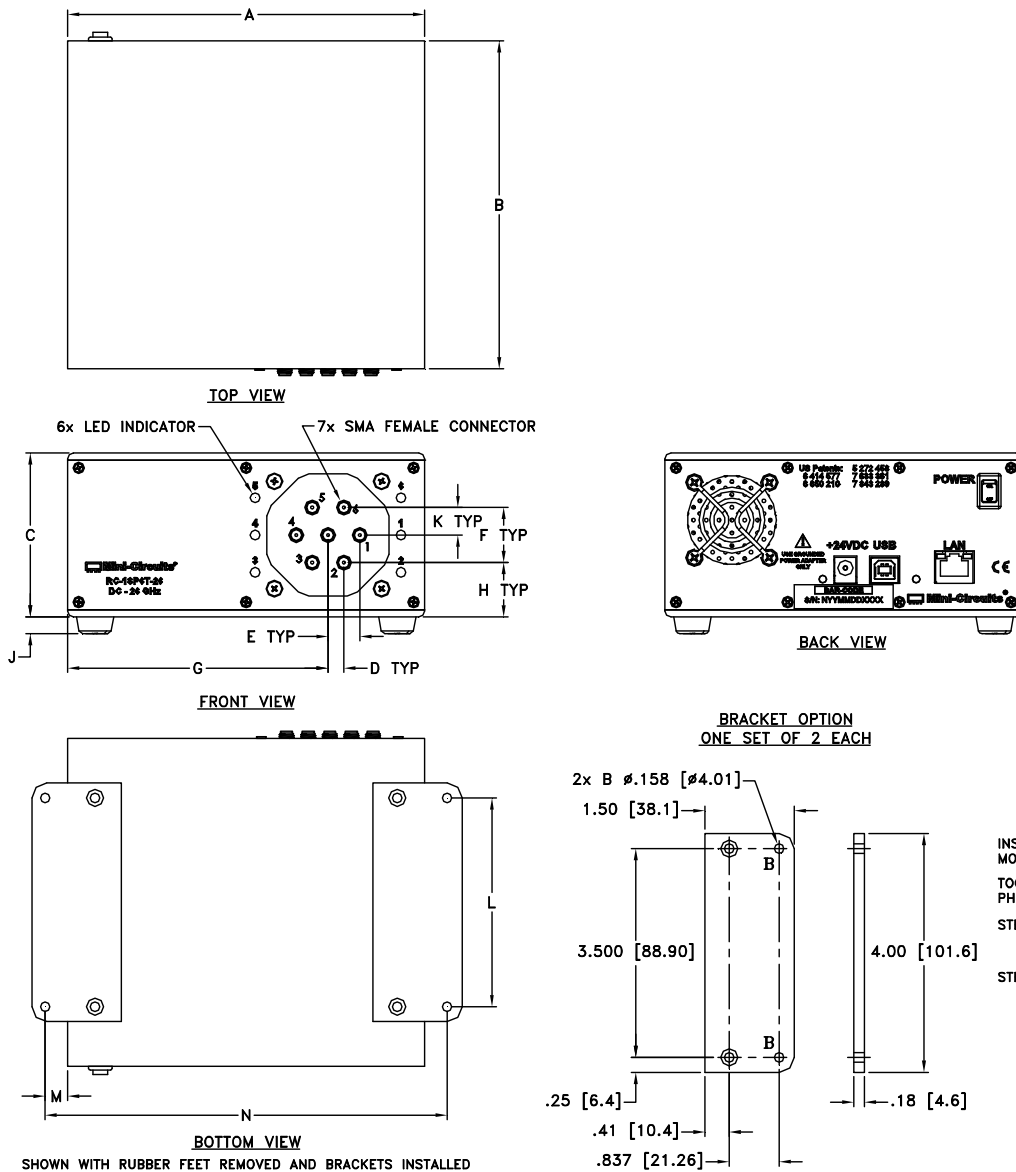

## Outline Dimensions ( inch mm )

A	B	C	D	E	F	G	H	J	K	L	M	N	P	wt
6.00	5.50	2.75	0.27	0.53	0.92	4.38	0.91	0.28	0.28	3.50	0.38	6.720	--	grams
152.40	139.70	69.85	6.86	13.46	23.37	111.25	23.11	7.11	7.11	88.90	9.53	170.69	--	1110

## Software Specifications

### Software & Documentation Download:

- Mini-Circuits' full software and support package including user guide, Windows GUI, DLL files, programming manual and examples can be downloaded free of charge from <https://www.minicircuits.com/softwaredownload/rfswitchcontroller.html>
- Please contact [testsolutions@minicircuits.com](mailto:testsolutions@minicircuits.com) for support

### Minimum System Requirements:

Parameter	Requirements	
Interface	USB HID & Ethernet (HTTP & Telnet)	
System Requirements	GUI	Windows 98 or later
	USB API DLL	Windows 98 or later and programming environment with ActiveX or .NET support
	USB Direct Programming	Linux, Windows 98 or later
	Ethernet	Windows, Linux or Mac computer with a network port and Ethernet TCP/IP support
Hardware	Pentium II or later with 256 MB RAM	

## Application Programming Interface (API)

### Ethernet Support:

- Simple ASCII / SCPI command set for attenuator control
- Communication via HTTP or Telnet
- Supported by most common programming environments

### USB Support (Windows):

- ActiveX COM DLL file for creation of 32-bit programs
- .NET library DLL file for creation of 32 / 64-bit programs
- Supported by most common programming environments (refer to application note AN-49-001 for summary of supported environments)

### USB Support (Linux):

- Direct USB programming using a series of USB interrupt codes

Full programming instructions and examples available for a wide range of programming environments / languages.

## Main Software Control Screen: Independent control of one SP6T

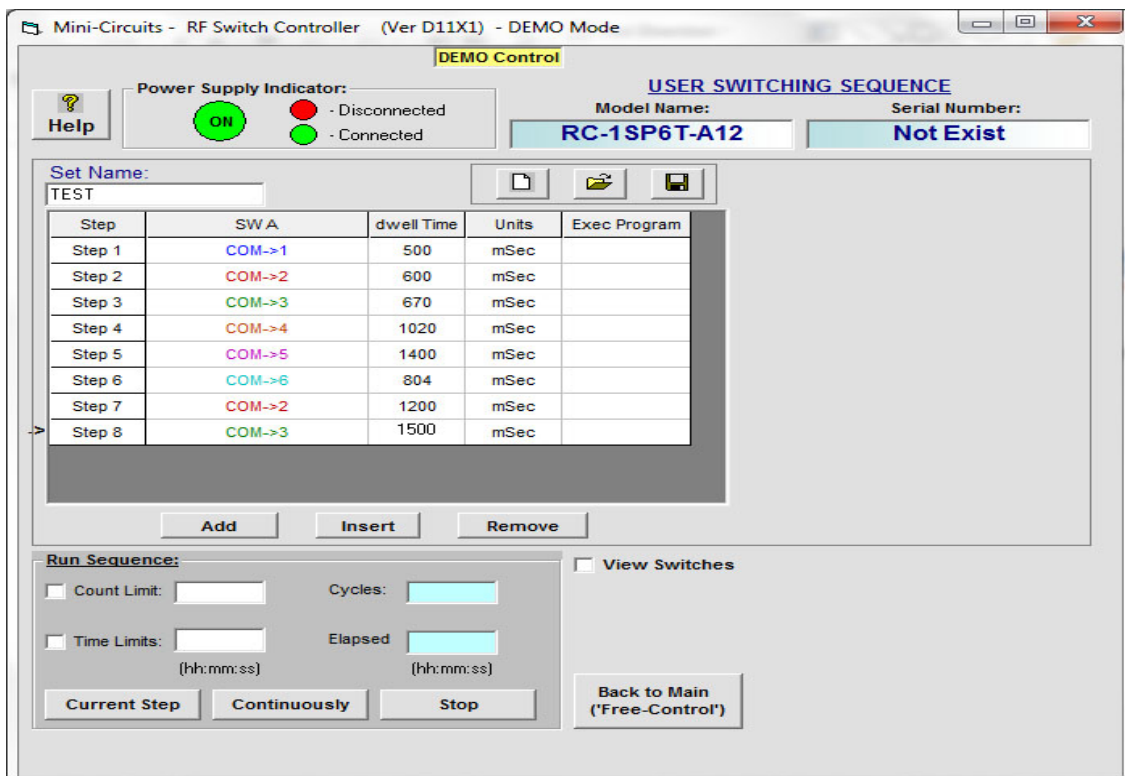
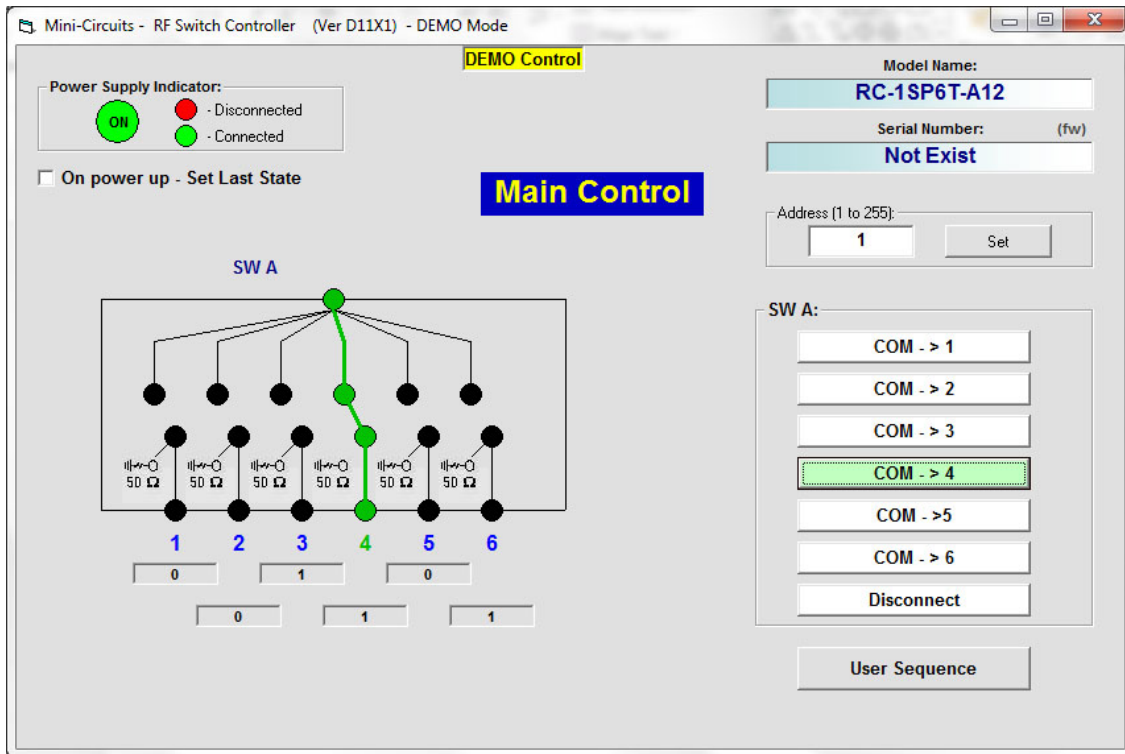

- Power handling is specified with RF applied to the COM port and output load connected to either 1,2,3,4,5 or 6 of the respective switch.
- When connecting a coaxial semi flex cable, tighten connectors alternately using an 8in/lb torque wrench to insure proper contact at each end.







## Ordering Information

Please contact Mini-Circuits' Test Solutions department for price and availability:  
[testsolutions@minicircuits.com](mailto:testsolutions@minicircuits.com)

Model	Description
RC-1SP6T-26	USB & Ethernet controlled SP6T switch matrix

Included Accessories	Part No.	Description
	AC/DC-24-3W1	AC/DC 24V <sub>DC</sub> Grounded Power Adaptor. Operating temperature: 0°C to +40°C, I <sub>Max</sub> =2.5A
	CBL-3W1-XX	AC Power Cord ( <i>Select one power cord from below with each Switch Matrix box</i> )
	USB-CBL-AB-3+	2.7 ft (0.8 m) USB Cable: USB type A(Male) to USB type B(Male)

AC Power Cords <sup>5</sup>	Part No.	Description
	CBL-3W1-US	Power Cord for United States
	CBL-3W1-EU	Power Cord for Europe
	CBL-3W1-UK	Power Cord for United Kingdom
	CBL-3W1-AU	Power Cord for Australia and China
	CBL-3W1-IL	Power Cord for Israel

<sup>5</sup>. If you need a Power cord for a country not listed please contact [testsolutions@minicircuits.com](mailto:testsolutions@minicircuits.com)

Optional Accessories	Description
USB-CBL-3+ (spare)	2.7 ft (0.8 m) USB Cable: USB type A(Male) to USB type B(Male)
USB-CBL-7+	6.8 ft (2.1 m) USB Cable: USB type A(Male) to USB type B(Male)
USB-CBL-11+	11 ft (3.4 m) USB Cable: USB type A(Male) to USB type B(Male)
CBL-RJ45-MM-5+	5 ft (1.5 m) Ethernet cable: RJ45(Male) to RJ45(Male) Cat 5E cable
BKT-272-08+	Bracket (One set of 2 each)

## Additional Notes

- Performance and quality attributes and conditions not expressly stated in this specification document are intended to be excluded and do not form a part of this specification document.
- Electrical specifications and performance data contained in this specification document are based on Mini-Circuit's applicable established test performance criteria and measurement instructions.
- The parts covered by this specification document are subject to Mini-Circuits standard limited warranty and terms and conditions (collectively, "Standard Terms"); Purchasers of this part are entitled to the rights and benefits contained therein. For a full statement of the Standard Terms and the exclusive rights and remedies thereunder, please visit Mini-Circuits' website at [www.minicircuits.com/MCLStore/terms.jsp](http://www.minicircuits.com/MCLStore/terms.jsp)

